

# Pyxis®

## SP-380 Handheld PTSA & Fluorescein Dual Meter User Manual



Water Professionals Deserve Better Tools.  
[www.pyxis-lab.com](http://www.pyxis-lab.com)

# SP-380 Handheld PTSA & Fluorescein Dual Meter User Manual

December 9, 2020

Rev. 1.31

**Pyxis Lab, Inc.**

1729 Majestic Dr. Suite 5

Lafayette, CO 80026 USA

[www.pyxis-lab.com](http://www.pyxis-lab.com)

© 2017 Pyxis Lab, Inc.

Pyxis Lab Proprietary and Confidential

## Table of Contents

<b>1</b>	<b>Introduction</b>	<b>2</b>
1.1	Main Features . . . . .	2
<b>2</b>	<b>Specifications</b>	<b>2</b>
<b>3</b>	<b>Unpacking Instrument</b>	<b>3</b>
3.1	Standard Accessories . . . . .	3
3.2	Optional Accessories . . . . .	4
<b>4</b>	<b>Installation</b>	<b>4</b>
4.1	Battery Installation . . . . .	4
<b>5</b>	<b>Instrument Overview</b>	<b>5</b>
5.1	Control Keys . . . . .	5
5.2	Main Module On/Off . . . . .	5
<b>6</b>	<b>Measurement</b>	<b>6</b>
6.1	PTSA Measurement . . . . .	6
6.2	Fluorescein Measurement . . . . .	7
<b>7</b>	<b>Calibration</b>	<b>8</b>
7.1	PTSA Calibration (Two-Point with Zero) . . . . .	8
7.2	Fluorescein Calibration . . . . .	9
<b>8</b>	<b>Device Information and Diagnosis</b>	<b>11</b>
8.1	Sample Cell Cleanliness Check . . . . .	12
8.2	Bluetooth Connection to Devices . . . . .	13
8.3	Factory Reset . . . . .	15
<b>9</b>	<b>Use with uPyxis® Mobile App</b>	<b>16</b>
9.1	Download uPyxis® Mobile App . . . . .	16
9.2	Connecting to uPyxis® Mobile App . . . . .	16
9.3	Setting Screen . . . . .	17
9.4	System Screen . . . . .	18
<b>10</b>	<b>Use with uPyxis® Desktop App</b>	<b>19</b>
10.1	Install uPyxis® Desktop App . . . . .	19
10.2	Connecting to uPyxis® Desktop App . . . . .	20
10.3	System Screen . . . . .	21
10.4	Datalog Screen . . . . .	22
10.5	Setting Screen . . . . .	22
<b>11</b>	<b>Device Maintenance and Precaution</b>	<b>23</b>
11.1	Maintenance Best Practices and Quick Tips . . . . .	23
11.2	Methods to Cleaning the SP-380 . . . . .	23
11.3	Storage . . . . .	24
<b>12</b>	<b>Contact Us</b>	<b>24</b>

## **Warranty Information**

### **Confidentiality**

The information contained in this manual may be confidential and proprietary and is the property of Pyxis Lab, Inc. Information disclosed herein shall not be used to manufacture, construct, or otherwise reproduce the goods described. Information disclosed herein shall not be disclosed to others or made public in any manner without the express written consent of Pyxis Lab, Inc.

### **Standard Limited Warranty**

Pyxis Lab warrants its products for defects in materials and workmanship. Pyxis Lab will, at its option, repair or replace instrument components that prove to be defective with new or remanufactured components (i.e., equivalent to new). The warranty set forth is exclusive and no other warranty, whether written or oral, is expressed or implied.

### **Warranty Term**

The Pyxis warranty term is thirteen (13) months ex-works. In no event shall the standard limited warranty coverage extend beyond thirteen (13) months from original shipment date.

### **Warranty Service**

Damaged or dysfunctional instruments may be returned to Pyxis for repair or replacement. In some instances, replacement instruments may be available for short duration loan or lease.

Pyxis warrants that any labor services provided shall conform to the reasonable standards of technical competency and performance effective at the time of delivery. All service interventions are to be reviewed and authorized as correct and complete at the completion of the service by a customer representative, or designate. Pyxis warrants these services for 30 days after the authorization and will correct any qualifying deficiency in labor provided that the labor service deficiency is exactly related to the originating event. No other remedy, other than the provision of labor services, may be applicable.

Repair components (parts and materials), but not consumables, provided during a repair, or purchased individually, are warranted for 90 days ex-works for materials and workmanship. In no event will the incorporation of a warranted repair component into an instrument extend the whole instrument's warranty beyond its original term.

### **Warranty Shipping**

A Repair Authorization (RA) Number must be obtained from Pyxis Technical Support before any product can be returned to the factory. Pyxis will pay freight charges to ship replacement or repaired products to the customer. The customer shall pay freight charges for returning products to Pyxis. Any product returned to the factory without an RA number will be returned to the customer. To receive an RMA you can generate a request on our website at <https://pyxis-lab.com/request-tech-support/>.

### **Pyxis Technical Support**

Contact Pyxis Technical Support at +1 (866) 203-8397, [service@pyxis-lab.com](mailto:service@pyxis-lab.com), or by filling out a request for support at <https://pyxis-lab.com/request-tech-support/>.

## 1 Introduction

The Pyxis SP-380 is a uniquely designed handheld multimeter that measures both PTSA and Fluorescein, simultaneously. It is a cuvette-less device. Less than 5 mL water sample is needed to fill the sample cell for proper measurement.

### 1.1 Main Features

The SP-380 includes the following features:

- Simultaneous measurement of the concentration of fluorescent tracer PTSA and the concentration of fluorescent tracer Fluorescein of a water sample.
- Pre-calibrated for measuring PTSA (pyrenetetrasulfonic acid) in the range of 0 to 300 ppb.
- The fluorescence PTSA measurement is automatically compensated for sample color and turbidity interference.
- Large color graphic screen that can be read in direct sunlight.

## 2 Specifications

**Table 1.** PTSA Specifications

Item	Specification*
Range	0–300 ppb
Accuracy	±1% or ±1.0 ppb
Resolution	0.1 ppb
Excitation Wavelength	365 nm
Emission Wavelength	410 nm
Wavelength Accuracy	±1 nm
Calibration Solution Point	0, 100, 200, and 300 ppb

\* With Pyxis's continuous improvement policy, these specifications are subject to change without notice.

**Table 2.** Fluorescein Specifications

Item	Specification*
Range	0–600 ppb
Accuracy	±1% or ±1.0 ppb
Resolution	0.1 ppb
Excitation Wavelength	470 nm
Emission Wavelength	520 nm
Wavelength Accuracy	±1 nm
Calibration Solution Point	0, 50, 250, and 500 ppb

\* With Pyxis's continuous improvement policy, these specifications are subject to change without notice.

**Table 3.** Temperature Specifications

Item	Specification*
Range	32–106 °F (0–41 °C)
Accuracy	±1%
Resolution	0.1 °F (0.05 °C)
Compensation Method	Automatic to 25 °C

\* With Pyxis's continuous improvement policy, these specifications are subject to change without notice.

**Table 4.** Other Specifications

Item	Specification*
Part Number (P/N)	50208
Display	320 × 240 TFT-LCD, visible under direct sunlight
Power Supply	4 AA alkaline batteries
Typical Battery Life	10,000 measurements
Dimension (L × W × H)	6.30 × 2.91 × 1.30 inch (160 × 74 × 33 mm)
Weight	0.68 lbs (310 g) <sup>†</sup>
Humidity	85% at 106 °F (41 °C)
Enclosure Rating	IP67

\* With Pyxis's continuous improvement policy, these specifications are subject to change without notice.

<sup>†</sup> Batteries excluded

### 3 Unpacking Instrument

Remove the instrument and accessories from the shipping container and inspect each item for any damage that may have occurred during shipment. Verify that all items listed on the packing slip are included. If any items are missing or damaged, please contact Pyxis Customer Service at [service@pyxislab.com](mailto:service@pyxislab.com).

#### 3.1 Standard Accessories

- Four (4) AA alkaline batteries
- Bluetooth/USB Adapter for Desktop P/N: MA-NEB
- User Manual available online at <https://pyxis-lab.com/support/>

## 3.2 Optional Accessories

The following optional accessories can be ordered from Pyxis Customer Service ([order@pyxis-lab.com](mailto:order@pyxis-lab.com)) or Pyxis E-Store at <https://pyxis-lab.com/shop/>.

**Table 5.** Optional Accessories

Accessory Name	Part Number (P/N)
Pyxis Carrying Case for Handheld Devices	50725
Pyxis 100 ppb PTSA Calibration Standard — 500 mL	21001
Pyxis 200 ppb PTSA Calibration Standard — 500 mL	21000
Pyxis 300 ppb PTSA Calibration Standard — 500 mL	21003
Pyxis 50 ppb Fluorescein Calibration Standard — 500 mL	FLUO-50
Pyxis 250 ppb Fluorescein Calibration Standard — 500 mL	FLUO-250
Pyxis 500 ppb Fluorescein Calibration Standard — 500 mL	FLUO-500
Pyxis Handheld Cleaning Kit	SER-02

## 4 Installation

### 4.1 Battery Installation

The SP-380 is powered by four alkaline batteries. Typical battery life lasts for 10,000 measurements or 10 months. When the battery capacity is critically low, the SP-380 will display a "LOW BATTERY" warning for 5 seconds and then automatically turn off.

**\*NOTE\*** Do not use rechargeable nickel cadmium (NiCad) or lithium batteries.

Replace the batteries to resume operation of the SP-380 after the battery warning. The SP-380 will automatically turn on in the measurement mode after new batteries are installation.

The SP-380 battery compartment, shown in Figure 1, is on the back side of the instrument. Batteries are held in place by a cover secured with two Phillips-head screws.

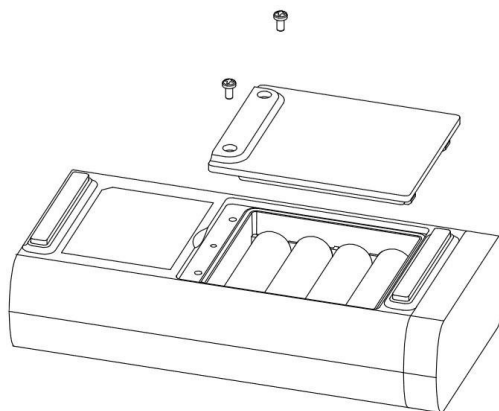

**Figure 1.** The SP-380 battery compartment

Install batteries using the following steps:

1. Remove the battery compartment cover by loosening the two screws.
2. Remove old batteries and dispose of them properly.
3. Following the positive and negative terminal signs in the compartment bottom, snap four new AA alkaline batteries firmly into the battery holder.
4. Replace the battery compartment cover and ensure that the sealing O-ring is lying flat on the battery holder.
5. Fasten the two screws.

**\*NOTE\*** Failure to properly seat the O-ring may result in water damage to the SP-380.

## 5 Instrument Overview

### 5.1 Control Keys

The SP-380 has three control keys, as shown in Figure 2. The left ( < ), right ( > ), and ok ( OK ) keys are used to launch actions indicated on the LCD display directly above the keys. The labels above the keys indicate the function associated with each key and functions can be changed in different operation modes.



Figure 2.

### 5.2 Main Module On/Off

**To turn on the SP-380:** Press ( OK ) momentarily and release.

**To turn off the SP-380:** Press and hold ( OK ) for about three seconds. Release ( OK ) when the LCD display turns off. The SP-380 turns itself off after 60 seconds without user interaction detected. This is done to conserve battery life.

**\*NOTE\*** This auto-time off setting may be customized by the user as desired through the **uPyxis®** Mobile or Desktop App.



## 6 Measurement

### 6.1 PTSA Measurement

When powered on, the SP-380 will default to the PTSA measurement mode. If the SP-380 is instead in Fluorescein measurement mode, press **PTSA** (  ) to switch to PTSA measurement mode. The water sample can be transferred to the sample cell using a pipette or filled directly from a faucet, sample bottle, or sample valve.

**\*NOTE\*** *Special care should be taken when pouring the sample into the cell to avoid air bubble entrainment, which can interfere with reading accuracy.*

Before beginning a measurement, use the sample water to rinse the sample cell at least three times. Allow 5–10 seconds for the SP-380 to stabilize. The values will be displayed in **white with a blue background** if a stable value is reached (Figure 2). For a sample containing 100 ppb PTSA, the measured PTSA should be stabilized within the range of 98–102 ppb.

**\*NOTE\*** *The time required to reach a stable reading may be slightly longer if the water sample temperature is significantly different than the environmental temperature at which the SP-380 had been equilibrated (stored).*

#### 6.1.1 High Color and Turbidity Warning

The SP-380 has extra channels to measure sample turbidity and color to automatically compensate sample color and turbidity interference. If sample turbidity and color values determined are too high, a PTSA measurement warning will be displayed. In such a case, the user should filter the sample for PTSA measurement.

## 6.2 Fluorescein Measurement

When powered on, the SP-380 will default to the PTSA measurement mode. Press **FC** (  ) to switch to Fluorescein measurement mode. The water sample can be transferred to the sample cell using a pipette or filled directly from a faucet, sample bottle, or sample valve.

**\*NOTE\*** *Special care should be taken when pouring the sample into the cell to avoid air bubble entrainment, which can interfere with reading accuracy.*

Before beginning a measurement, use the sample water to rinse the sample cell at least three times. Allow 5–10 seconds for the SP-380 to stabilize. The values will be displayed in **white with a blue background** if a stable value is reached (Figure 3). For a sample containing 10.0 ppb Fluorescein, the measured Fluorescein should be stabilized within the range of 9.8–10.2 ppb.

**\*NOTE\*** *The time required to reach a stable reading may be slightly longer if the water sample temperature is significantly different than the environmental temperature at which the SP-380 had been equilibrated (stored).*

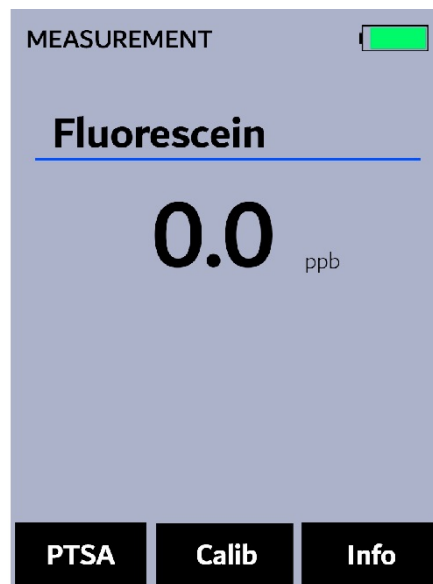

Figure 3.

## 7 Calibration

### 7.1 PTSA Calibration (Two-Point with Zero)

1. Rinse the sample cell three times with DI water. Fill the sample cell with DI water.

**\*NOTE\*** In emergency, “non-PTSA” water, such as city water, may be used, but re-calibrate using DI water for the zero step as soon as it is available.

2. Power on the SP-380 by pressing **OK** . Allow 5–10 seconds for the SP-380 to stabilize.
3. The unit is actively reading and displaying PTSA. The values will be very low if DI water is used; conductivity value is not critical but PTSA value should be near zero. A low non-zero value (e.g. 0.2 or 0.4, etc.) is not problematic.
4. Press **Calib** ( **>** ) to launch the **PTSA CALIBRATION** screen (Figure 4).
5. Press **Zero** ( **<** ) to start the zero (blank) calibration.
6. If the calibration succeeds, a checkmark ( **✓** ) and instructions for the slope calibration will appear (Figure 5).
7. Rinse the sample cell three times with the desired PTSA standard. Fill the sample cell with the desired PTSA standard.
8. Press **Cycle** ( **<** ) to cycle between the PTSA standards 100, 200, and 300 ppb (it repeats). Ensure the value selected matches the desired PTSA standard in the sample cell.
9. Press **Slope** ( **>** ) to start the slope calibration.
10. If the calibration succeeds, a checkmark ( **✓** ), a “**Calibration Success**” message will appear (Figure 6). Otherwise, a warning message is displayed.
11. Calibration is now complete. Press **Exit** ( **OK** ) to return to measurement mode.

**\*NOTE\*** If **Exit** is pressed before the second checkmark appears, the calibration will not be completed and must be re-done.

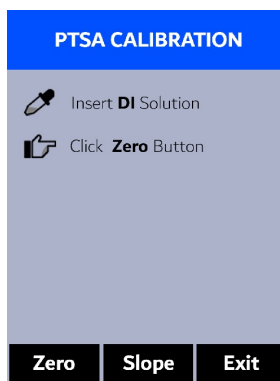

Figure 4.

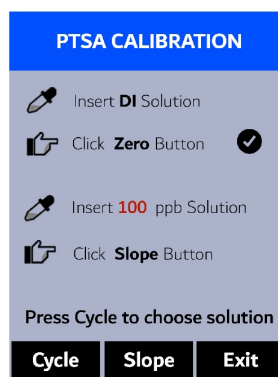

Figure 5.

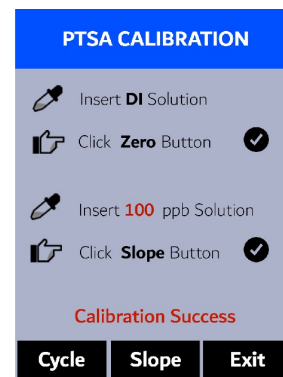

Figure 6.

## 7.2 Fluorescein Calibration

The SP-380 is designed to provide a flexible calibration procedure. The user can start with the two-point (DI water and 50 ppb fluorescein) calibration and progressively add a three- and four-point calibration with 250 ppb and 500 ppb fluorescein, respectively. This allows the user to choose a procedure based on the need of measurement accuracy and the target fluorescein range.







**\*NOTE\*** *It is highly recommended to complete a full, four-point calibration for the best accuracy across the entire fluorescein measurement range of the SP-380 (0–600 ppb).*

Follow the steps below to conduct either a two-point, three-point, or four-point fluorescein calibration:





### 7.2.1 Two-Point Calibration

1. Rinse the sample cell three times with deionized (DI) water. Fill the sample cell with the DI water.
2. Power on the SP-380 by pressing **OK** . Allow 5–10 seconds for the SP-380 to stabilize.
3. Press **FC** ( **<** ) to switch to Fluorescein measurement mode.
4. Press **>** to launch the **FLCN CALIBRATION** screen (Figure 7).
5. Press **Zero** ( **<** ) to start the zero (blank) calibration.
6. If the calibration succeeds, a checkmark ( **✔** ) and instructions for the 50 ppb slope calibration will appear (Figure 8).
7. Rinse the main module sample cell three times with 50 ppb Fluorescein standard. Fill the sample cell with the standard.
8. Press **Slope** ( **<** or **>** ) to start 50 ppb slope calibration.
9. If the calibration succeeds, a second checkmark ( **✔** ) "**Calibration Success**" message will appear (Figure 9). Otherwise, a warning message is displayed.
10. After a successful two-point calibration, choose one of two options:
  - (a) Press **Continue** ( **<** or **>** ) to proceed to a three- or four-point calibration, or
  - (b) Press **Exit** ( **OK** ) to end the calibration process at a two-point calibration and return to Fluorescein measurement mode.

### 7.2.2 Three-Point Calibration

11. Rinse the sample cell three times with 250 ppb Fluorescein standard. Fill the sample cell with the standard.
12. Press **Slope** (  or  ) to start 250 ppb slope calibration.
13. If the calibration succeeds, a second checkmark (  ) "Calibration Success" message will appear (Figure 10). Otherwise, a warning message is displayed.
14. After a successful three-point calibration, choose one of two options:
  - (a) Press **Continue** (  or  ) to proceed to a four-point calibration, or
  - (b) Press **Exit** (  ) to end the calibration process at a three-point calibration and return to Fluorescein measurement mode.

### 7.2.3 Four-Point Calibration

15. Rinse the main module sample cell three times with 500 ppb Fluorescein standard. Fill the sample cell with the standard.
16. Press **Slope** (  or  ) to start 500 ppb slope calibration.
17. If the calibration succeeds, a second checkmark (  ) "Calibration Success" message will appear (Figure 11). Otherwise, a warning message is displayed.
18. Calibration is now complete. Press **Exit** (  ) to return to Fluorescein measurement mode.

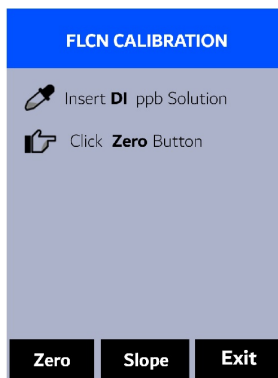

Figure 7.



Figure 8.

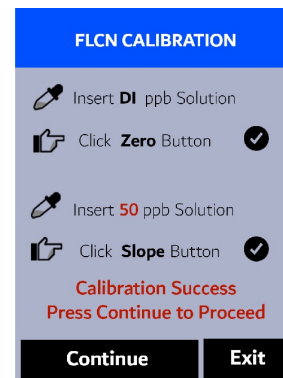

Figure 9.

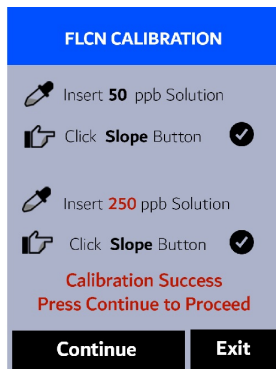

Figure 10.

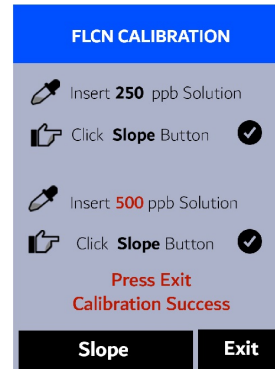

Figure 11.

## 8 Device Information and Diagnosis

The **DEVICE INFORMATION** screen is launched when **Info** (OK) is pressed in the measurement mode. This screen contains the device serial number, software version, and hardware version (Figure 12). The battery life as a percentage and the MAC addresses for main module also shown.

Press **Diagnosis** (<) to launch the **SYSTEM DIAGNOSIS** screen where raw measurement data are displayed (Figure 13). The information has no use for normal operation, but instead is used for device troubleshooting. Provide an image of both the **DEVICE INFORMATION** screen and the **SYSTEM DIAGNOSIS** screen when you contact Pyxis ([service@pyxis-lab.com](mailto:service@pyxis-lab.com)) for troubleshooting your device or call +1 (866) 203-8397.

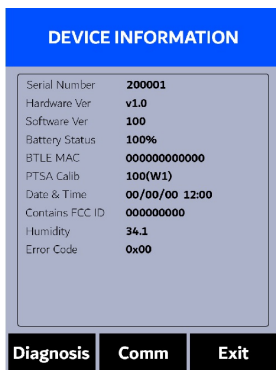

Figure 12.

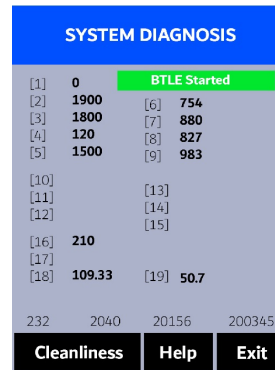

Figure 13.

## 8.1 Sample Cell Cleanliness Check

The SP-380 is designed to provide reliable and accurate measurement on PTSA and Fluorescein. Heavy fouling will prevent the light from reaching the sensor, resulting in inaccurate readings. It is suggested that the SP-380 be checked for fouling and cleaned on a monthly basis. Heavily contaminated waters may require more frequent cleanings. Cleaner water sources with less contamination may not require cleaning for several months. The SP-380 is designed to carry out a Cleanliness Check as described below:

1. Power on the SP-380 by pressing **OK** .
2. Press **Info** ( **OK** ) to launch the **DEVICE INFORMATION** screen.
3. Press **Diagnosis** ( **<** ) to launch the **SYSTEM DIAGNOSIS** screen.
4. Allow 5–10 seconds for the message in the top-right corner of the display change from **Starting BTLE...** to **BTLE Started**
5. Press **Cleanliness** ( **<** ). An instruction prompt appears to ask the user to put DI water into the main module sample cell (Figure 14).
6. Pour DI water into the main module sample cell.
7. Press **Confirm** ( **<** , **>** , or **OK** ). The instruction prompt will disappear and the SP-380 displays a countdown toward the bottom of the display.
8. Once the Cleanliness Check is completed a **Clean** message (Figure 15) or **Sample cell fouled** message (Figure 16) will appear towards the bottom of the display.
9. Cleanliness check is now complete. Press **Exit** ( **OK** ) to return to measurement mode.

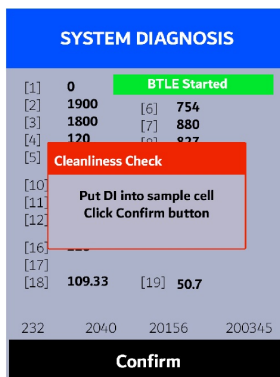

Figure 14.



Figure 15.

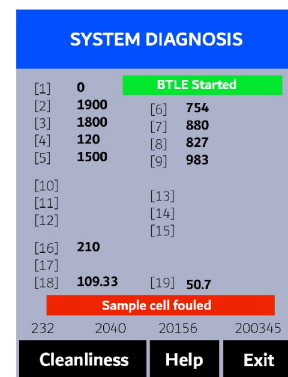

Figure 16.

## 8.2 Bluetooth Connection to Devices

The SP-380 uses a built-in Bluetooth Low Energy Connection (BTLE) to connect wirelessly to a smart phone via the **uPyxis®** Mobile App or to a computer via the included Bluetooth Adapter (P/N: MA-NEB) and the **uPyxis®** Desktop App. To allow the SP-380 to connect via Bluetooth with other devices follow the steps below:

1. Power on the SP-380 by pressing **OK**.
2. Press **Info** (**OK**) to launch the **DEVICE INFORMATION** screen.
3. Press **Diagnosis** (**<**) to launch the **SYSTEM DIAGNOSIS** screen.
4. Allow 5–10 seconds for the message in the top-right corner of the display change from **Starting BTLE...** to **BTLE Started** (Figure 13).
5. Choose to connect via one of two options:
  - (a) The **uPyxis®** Mobile App (see the **Use with uPyxis® Mobile App** section), or
  - (b) The **uPyxis®** Desktop App (see the **Use with uPyxis® Desktop App** section).

### 8.2.1 Calibrate an ST-500 Series Sensor with the SP-380 via Bluetooth

The SP-380 can be used to verify the result of an inline Pyxis ST-500 Series sensor by measuring the sample water taken from the inline sensor sample line. The SP-380 can then be used to calibrate the inline sensors over the Bluetooth connection. To calibrate an inline sensor, follow the steps below:

1. Power on the SP-380 by pressing **OK**.
2. Press **Info** (**OK**) to launch the **DEVICE INFORMATION** screen.
3. Press **Comm** (**>**) to launch the **COMMUNICATION** screen (Figure 17).
4. Press **Scan** (**<**) to begin scanning for Bluetooth devices.
5. Discoverable devices will begin to populate on the display with their name and MAC-Address (Figure 18).
6. If more than one device appears in the **Device list**, press **»** (**>**) to cycle through the devices.
7. If no devices or the incorrect device appear in the **Device list**, press **Scan** (**OK**) to re-scan for discoverable devices.
8. Press **Connect** (**OK**) to begin pairing to the selected sensor.
9. When the connection is established, the SP-380 displays the latest PTSA measurement from the connected sensor (Figure 19).
10. Fill the main module sample cell with the same sample water that the sensor is measuring.
11. Press **Read** (**>**) to see PTSA measurement from the SP-380 along with the sensor measurement (Figure 20).
12. Press **Calib** (**OK**) to begin sensor PTSA calibration.



13. The SP-380 will take the sensor PTSA measurement three times to verify the calibration (Figure 21).

**\*NOTE\*** It takes about one minute for the sensor to approach the calibrated reading and the three verifying readings may not be exactly the same as the value measured by the SP-380. Press **Read** ( > ) again to take more readings from the sensor, if necessary.

14. If the calibration is successful, a "Verify calibration - OK" message will appear on the top of the display (Figure 22).

15. Calibration is now complete. Long press **Calib** ( OK ) to return to measurement mode.

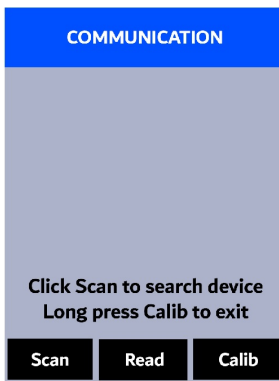

Figure 17.

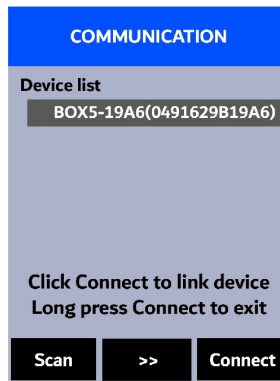

Figure 18.

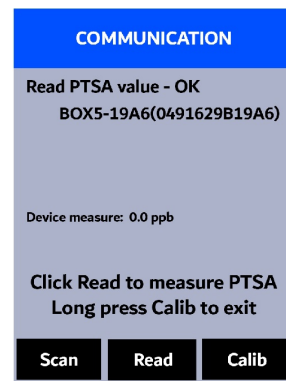

Figure 19.

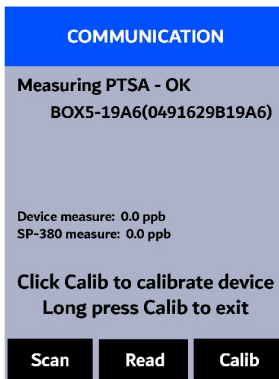

Figure 20.

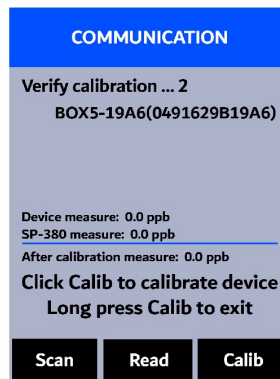

Figure 21.

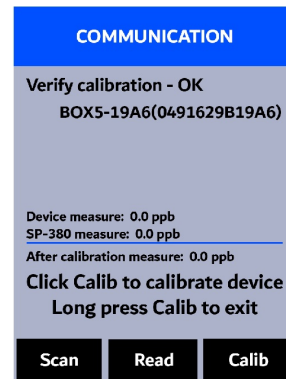

Figure 22.

### 8.3 Factory Reset

Use the following steps to restore all device parameters to factory default:

1. Power on the SP-380 by pressing **OK**.
2. Press **Info** (**OK**) to launch the **DEVICE INFORMATION** screen.
3. Press **Diagnosis** (**<**) to launch the **SYSTEM DIAGNOSIS** screen.
4. Allow 5–10 seconds for the message in the top-right corner of the display change from **Starting BTLE...** to **BTLE Started**.
5. Press **Help** (**>**) to launch the **HELP** screen (Figure 23).
6. Press **Factory Reset** (**<** or **>**). The display updates as shown in Figure 24 appear and the user can choose one of three options:
  - (a) Press **OK** to start the factory reset, or
  - (b) Press **Cancel** (**<**) to return to the **HELP** screen, or
  - (c) Press **Exit** (**>**) to abandon the factory reset entirely.
7. After a successful factory reset, the message “Factory reset done.” will appear on the display.
8. Press **Exit** (**OK**) to return to measurement mode.



Figure 23.



Figure 24.

## 9 Use with uPyxis® Mobile App

### 9.1 Download uPyxis® Mobile App

Download uPyxis® Mobile App from [Apple App Store](#) or [Google Play](#).



Figure 25. uPyxis® Mobile App installation

### 9.2 Connecting to uPyxis® Mobile App

Connect the SP-380 sensor to a mobile smart phone according to the following steps:

1. Follow the steps in the **Bluetooth Connection to Devices** section to make the SP-380 discoverable.
2. Open uPyxis® Mobile App.
3. On uPyxis® Mobile App, pull down to refresh the list of available Pyxis devices.
4. If the connection is successful, the SP-380 and its Serial Number (SN) will be displayed (Figure 26).
5. Press on the **SP-380 image**.

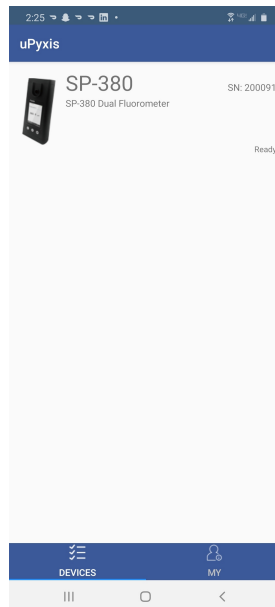

Figure 26.

### 9.3 Setting Screen

When connected, the uPyxis® Mobile App will default to the **Setting** screen. From the **Setting** screen, the user can set the **Power off time** and **Screen off time** in seconds.

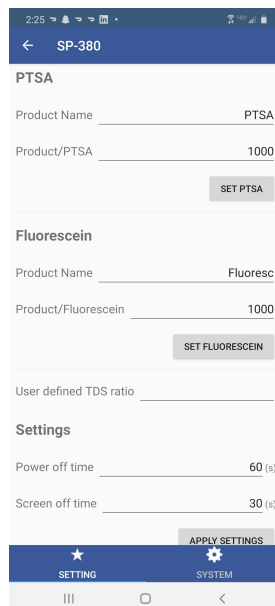

Figure 27.

## 9.4 System Screen

From the **System** screen, users can change the **Device Name**, find the **Serial Number**, **Hardware Version**, and **Firmware Version**, as well as update the firmware of the SP-380 by pressing **Check Update**. If a firmware update is available, press **Get Firmware**. Once the new firmware is downloaded, press **Upgrade Firmware**.

**\*NOTE\*** *The firmware update process takes some time and will require the SP-380 to stay within range (approximately 10 ft without obstructions) for the entire duration of the update.*

Once the update is complete, the SP-380 will reboot which will disconnect the SP-380 from the uPyxis® Mobile App.

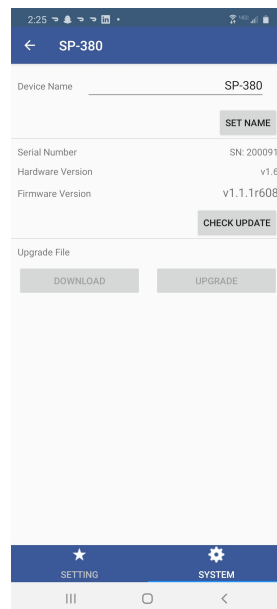
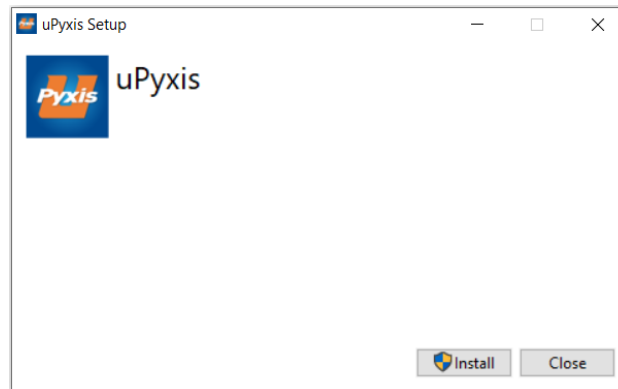

Figure 28.

## 10 Use with uPyxis® Desktop App

### 10.1 Install uPyxis® Desktop App

Download the latest version of **uPyxis®** Desktop software package from: <https://pyxis-lab.com/upyxis/> this setup package will download and install the Microsoft.Net Framework 4.5 (if not previously installed on the PC), the USB driver for the USB-Bluetooth adapter (MA-NEB), the USB-RS485 adapter (MA-485), and the main **uPyxis®** Desktop application. Double click the **uPyxis.Setup.exe** file to install.



**Figure 29.** uPyxis® Desktop App installation

Click **Install** to start the installation process. Follow the screen instructions to complete the USB driver and uPyxis installation.

## 10.2 Connecting to uPyxis® Desktop App

Connect the SP-380 to a Windows computer using a Bluetooth/USB adapter (P/N: MA-NEB) according to the following steps:

1. Follow the steps in the **Bluetooth Connection to Devices** section to make the SP-380 discoverable.
2. Plug the Bluetooth/USB adapter into a USB port in the computer.
3. Launch **uPyxis®** Desktop App.
4. On **uPyxis®** Desktop App, click Device → **Connect via USB-Bluetooth** (Figure 30).
5. If the connection is successful, the SP-380 and its Serial Number (SN) will be displayed in the left pane of the **uPyxis®** window.

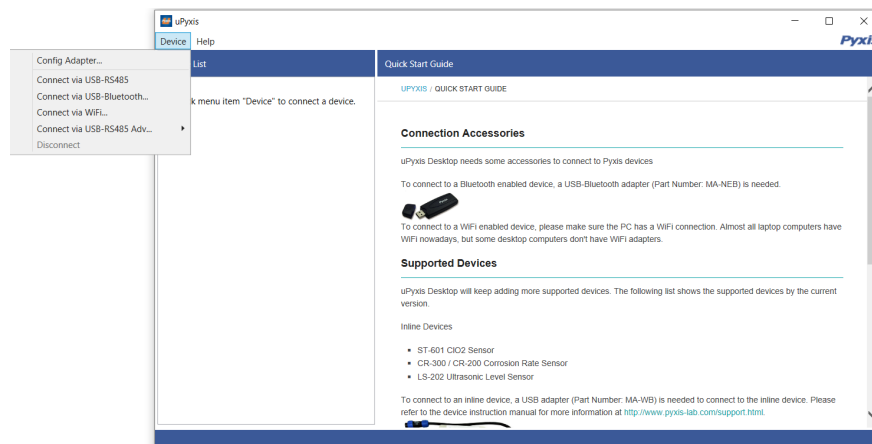

Figure 30.

### 10.3 System Screen

Once connected to the device, a picture of the device will appear on the top-left corner of the window and the **uPyxis**® Desktop App will default to the **System** screen. From the **System** screen, users can upgrade the firmware by selecting an appropriate firmware file (contact [service@pyxis-lab.com](mailto:service@pyxis-lab.com) for these firmware files) and clicking **Upgrade Firmware**.

**\*NOTE\*** *The firmware update process takes some time and will require the SP-380 to stay within range (approximately 10 ft without obstructions) for the entire duration of the update.*

Once the update is complete, the SP-380 will reboot which will disconnect the SP-380 from the **uPyxis**® Mobile App.

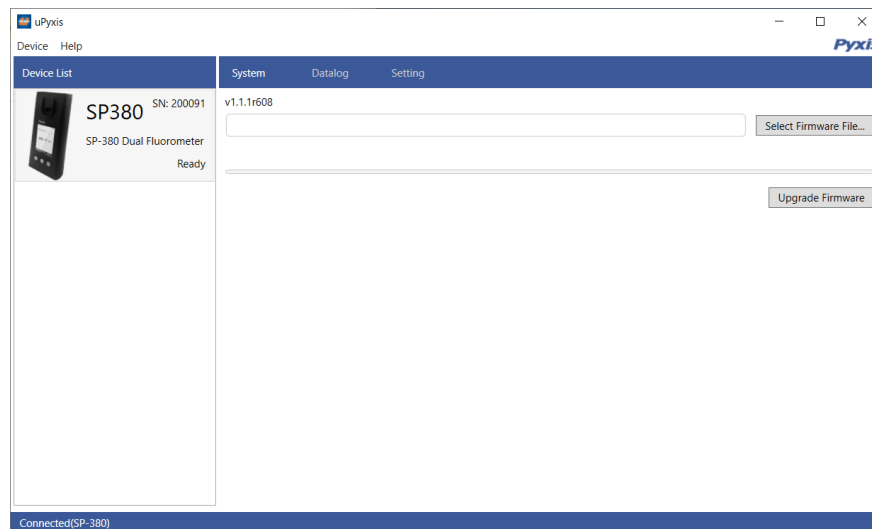

Figure 31.



### 10.4 Datalog Screen

From the **Datalog** screen, the user can view, delete, and export the internal log files of the SP-380 by clicking **Read Datalog List** and selecting the desired datalog (these are separated by month). The SP-380 will then populate any relevant log event from the selected datalog which can be viewed in more detail by clicking **Read Datalog**, deleted by clicking **Delete**, or exported by clicking **Export as .CSV File**.

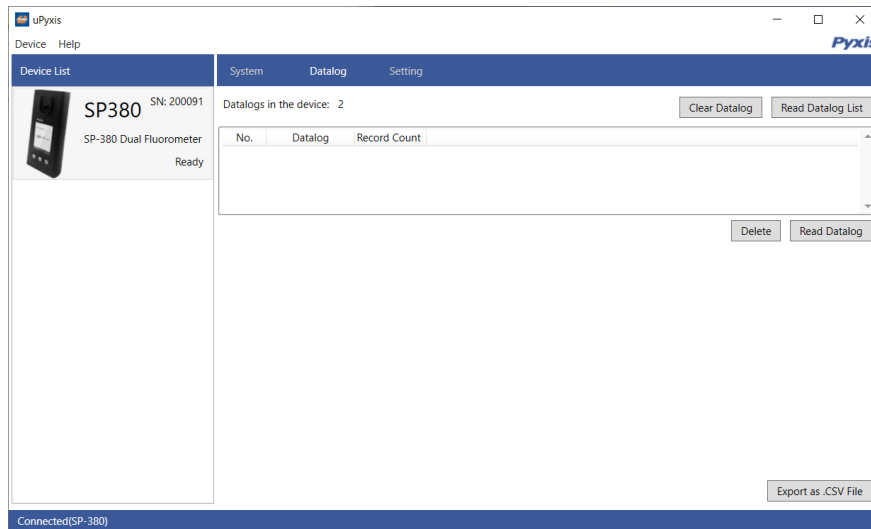

Figure 32.

### 10.5 Setting Screen

From the **Setting** screen, the user can set the **Power off time** and **Screen off time** in seconds.

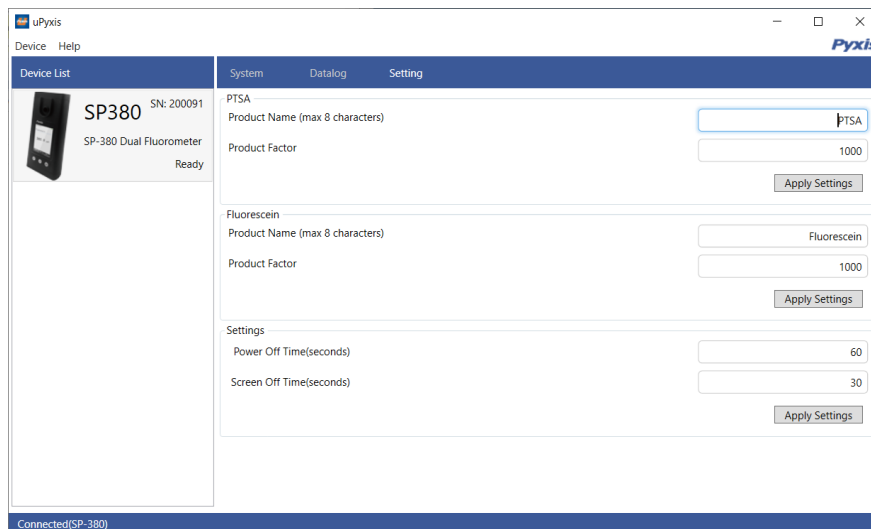

Figure 33.

## 11 Device Maintenance and Precaution

### 11.1 Maintenance Best Practices and Quick Tips

For greatly increased working life and ease of use of the SP-380 follow the list of maintenance best practices and quick tips below:

- Rinse the sample cell at least three times with the desired solution before turning on.
- After a successful calibration, the unit does not automatically return to the measurement mode. If Exit is held down too long the unit will power down rather than returning to the measurement mode.
- After returning to measurement mode after calibration, rinse several times with the first sample. The unit will continue to read the sample values without any further key presses if it has not powered off. If there are no key presses for 20 seconds the screen will darken, and after another 20 seconds without key activity will power down. The press of any key while the screen is dark will reset the timer and the screen will re-light. (This press will not step along the calibration process; the next press needed will still be required in the sequence).
- Always rinse the unit with clean water after use and dry by clean tissue or paper towel.

### 11.2 Methods to Cleaning the SP-380

A light deposit on quartz glass inside the sample cell can be cleaned by a Q-tip. Aged heavy deposition, especially iron oxide deposited, can be removed using a cleaning solution that is capable of removing iron, such as the Pyxis Handheld Device Cleaning Solution Kit (P/N: SER-02) available from Pyxis online E-Store <https://pyxis-lab.com/product/handheld-device-cleaning-kit/>.



**Figure 34.** Handheld Device Cleaning Solution Kit

To clean the SP-380 pour cleaning solution into the sample cell for 10 minutes. Rinse the sample cell with distilled water and use the Cleanliness Check (see the **Sample Cell Cleanliness Check** section) to confirm that the SP-380 is clean. Repeat the process as needed until the Cleanliness Check shows **Clean**.

### **11.3 Storage**

Do not expose the SP-380 to an extreme high or low temperature condition such as leaving the SP-380 inside an unattended automobile.

## **12 Contact Us**

**Pyxis Lab, Inc**

1729 Majestic Dr. Suite 5

Lafayette, CO 80026 USA

[www.pyxis-lab.com](http://www.pyxis-lab.com)

Phone: +1 (866) 203-8397

Email: [service@pyxis-lab.com](mailto:service@pyxis-lab.com)